

# Solid State Relays SOLITRON MINI - With Integrated Heatsink Type RJ2A



- AC semiconductor contactor
- Two pole switching with common control input
- Direct copper bonding (DCB) technology
- LED-indication
- Self-lifting power terminals
- Operational ratings : Up to 2 x 18AACrms and 480VAC
- Blocking voltage: Up to 1200V<sub>p</sub>
- Opto-isolation > 4000VACrms

## Product Description

The SOLITRON RJ2A MINI is a two pole Solid State Contactor designed to replace electro-mechanical contactors in industrial heating and motor applications, especially when switching is frequent. The two switching poles in the RJ2A MINI are simultaneously activated upon application of the control voltage. A Green LED indicates the status of the control input. The relay will switch on when the sinusoidal curve crosses zero and switches off when the current crosses zero. Two 2.5mm<sup>2</sup> cables can be con-

nected in each screw terminal to allow looping. A removable IP20 cover allows connection of a 4mm<sup>2</sup> cable with crimped terminal. The control voltage is supplied via a screw plug-in connector on the front of the device. The product is ready to mount on DIN-Rail or chassis and comes with integral heatsink. The heatsink is moved to the back for optimal space saving in the panel and easy wire mounting at the front of the relay. The standard housing dimensions enable installation in limited space.

## Ordering Key

**RJ 2 A 48 D 12 E**

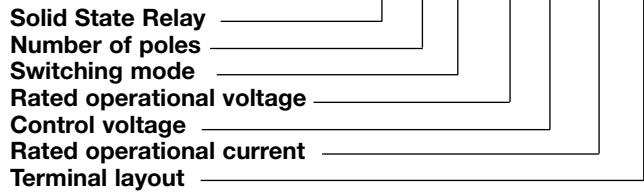

## Type Selection

Switching mode	Rated operational voltage	Control voltage	Rated operational current	Terminal layout
A: Zero switching	22: 220VACrms 48: 480VACrms	D: 4 - 32VDC	12: 2 x 12AACrms 18: 2 x 18AACrms	E: Contactor

## Selection Guide

Rated operational voltage	Blocking voltage	Control voltage	Rated operational current	
			2 x 12A	2 x 18A
220VACrms	650V <sub>p</sub>	4 - 32VDC	RJ2A22D12E	RJ2A22D18E
480VACrms	1200V <sub>p</sub>	4 - 32VDC	RJ2A48D12E	RJ2A48D18E

## General Specifications

	RJ2A22...	RJ2A48...
Operational voltage range	24 to 280VAC	42 to 530VAC
Blocking voltage	650V <sub>p</sub>	1200V <sub>p</sub>
Operational frequency range	45 to 65Hz	45 to 65Hz
Power factor	≥ 0.5 @ 220VACrms	≥ 0.5 @ 480VACrms
Approvals	UL, cUL	UL, cUL
CE-marking	Yes	Yes
Pollution degree	2	2

## Output Specifications

	RJ2A...12	RJ2A...18
Rated operational current AC51 @Ta=25°C AC53a @Ta=25°C	2 x 12AACrms 2 x 5AACrms	2 x 18AACrms 2 x 15AACrms
Min. operational current	350mAACrms	250mAACrms
Rep. overload current t = 1s	< 35AACrms	<125AACrms
Non rep. surge current Tj(init.) = 25°C and t = 10 ms	300A <sub>p</sub>	600A <sub>p</sub>
Off-state leakage current @ rated voltage and frequency	< 3mArms	< 3mArms
I <sup>2</sup> t for fusing t =10 ms	450A <sup>2</sup> s	1800A <sup>2</sup> s
On-state voltage drop @ rated current	1.6Vrms	1.6Vrms
Critical dV/dt off-state	500V/μs	500V/μs

## Input Specifications

Control voltage range	4 - 32VDC
Pick-up voltage	3.8VDC
Reverse voltage	32VDC
Drop-out voltage	1.2VDC
Max. input current	24mA
Response time pick-up	≤ 1/2 cycle
Response time drop-out	≤ 1/2 cycle

## Thermal Specifications

Operating temperature	-30 to +70°C (-22 to +158°F)
Storage temperature	-40 to +100°C (-40 to +212°F)

## Isolation

Rated isolation voltage	≥ 4000 VACrms
Input to output	≥ 4000 VACrms
Output to case	≥ 4000 VACrms

## Housing Specifications

Weight	Approx. 300g
Housing material	PBT Flame retardant
Control terminal	
Terminal screws	M3
Max. terminal tightening torque	0.8Nm with Philips bit
Min. cross-sectional area of cable (stranded)	1 x 0.05mm <sup>2</sup> (1 x AWG30)
Max. cross-sectional area of cable (stranded)	1 x 2.5mm <sup>2</sup> (1 x AWG12) or 2 x 1.5mm <sup>2</sup> (2 x AWG16)
Power terminal	
Terminal screws	M4
Maximum tightening torque	2Nm with Posidriv 2 bit
Min. cross-sectional area of cable (stranded)	1 x 0.5mm <sup>2</sup> (1 x AWG20)
Max. cross-sectional area of cable (stranded)	2 x 2.5mm <sup>2</sup> (2 x AWG14)
Max. cross-sectional area of cable with crimped terminal	1 x 4.0mm <sup>2</sup> (1 x AWG12)

## Terminal Layout

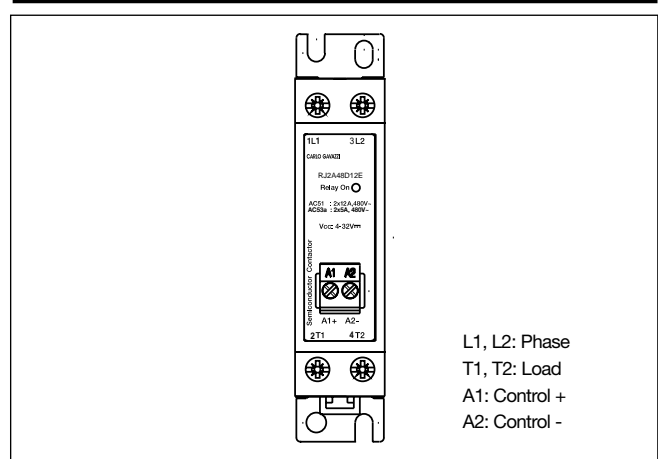

## Derating Curve

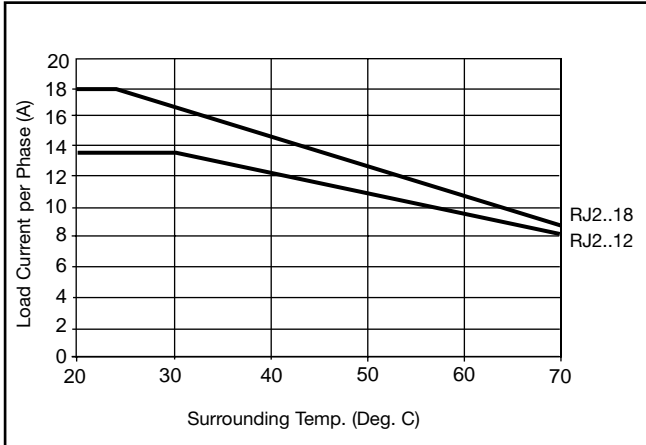

## Dissipation Curve

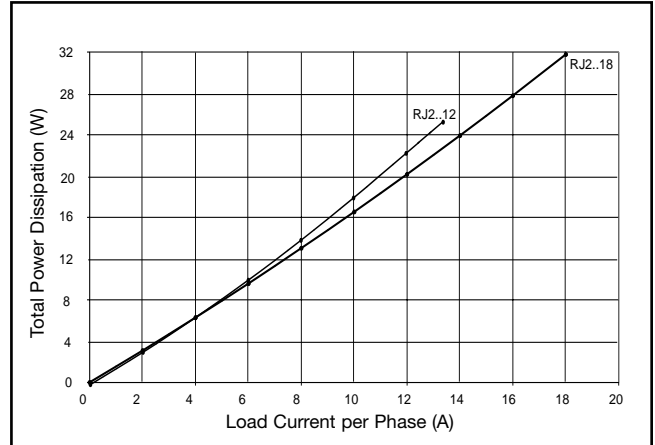

## Derating vs. Spacing Curves

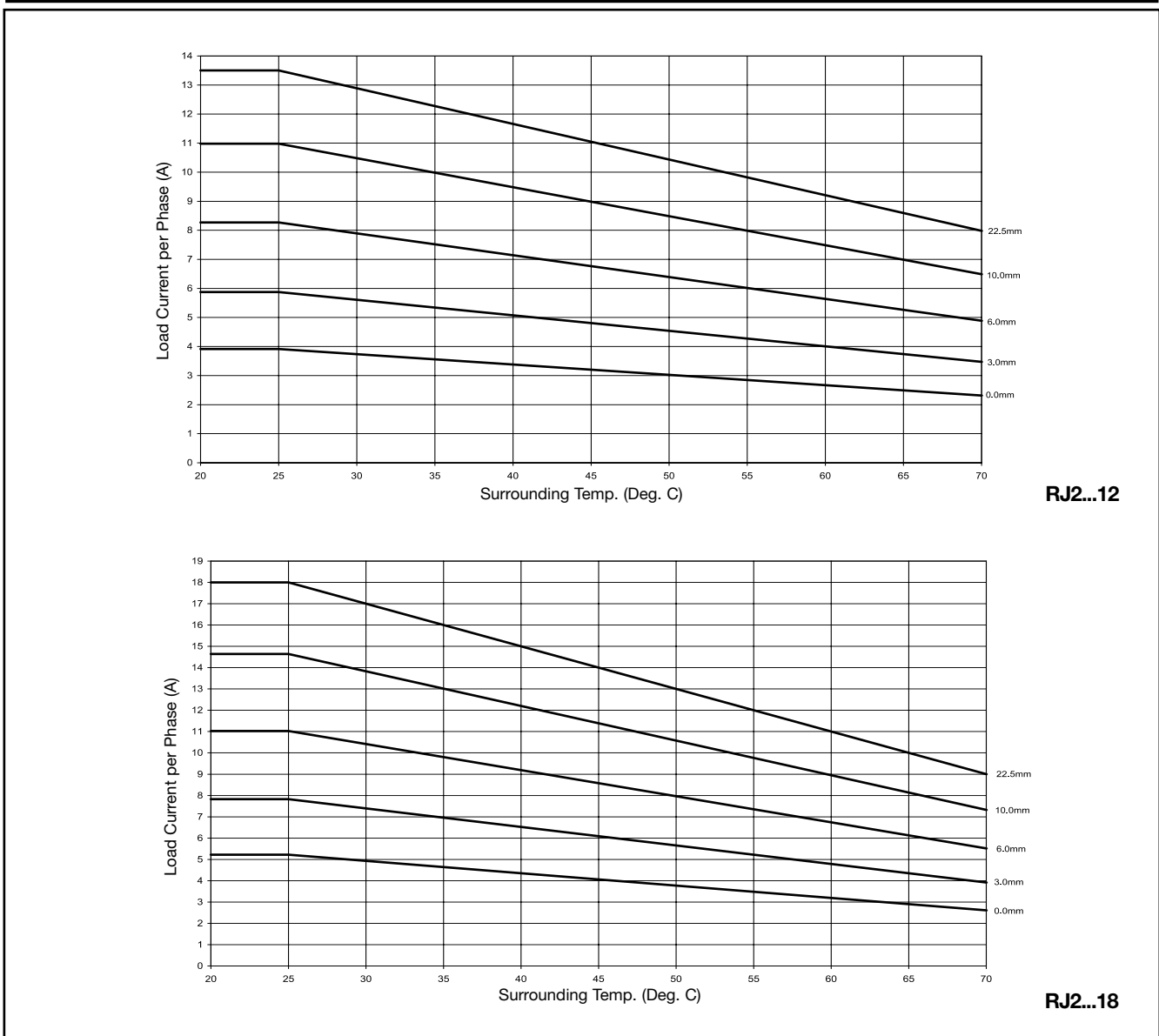

## Connection Example

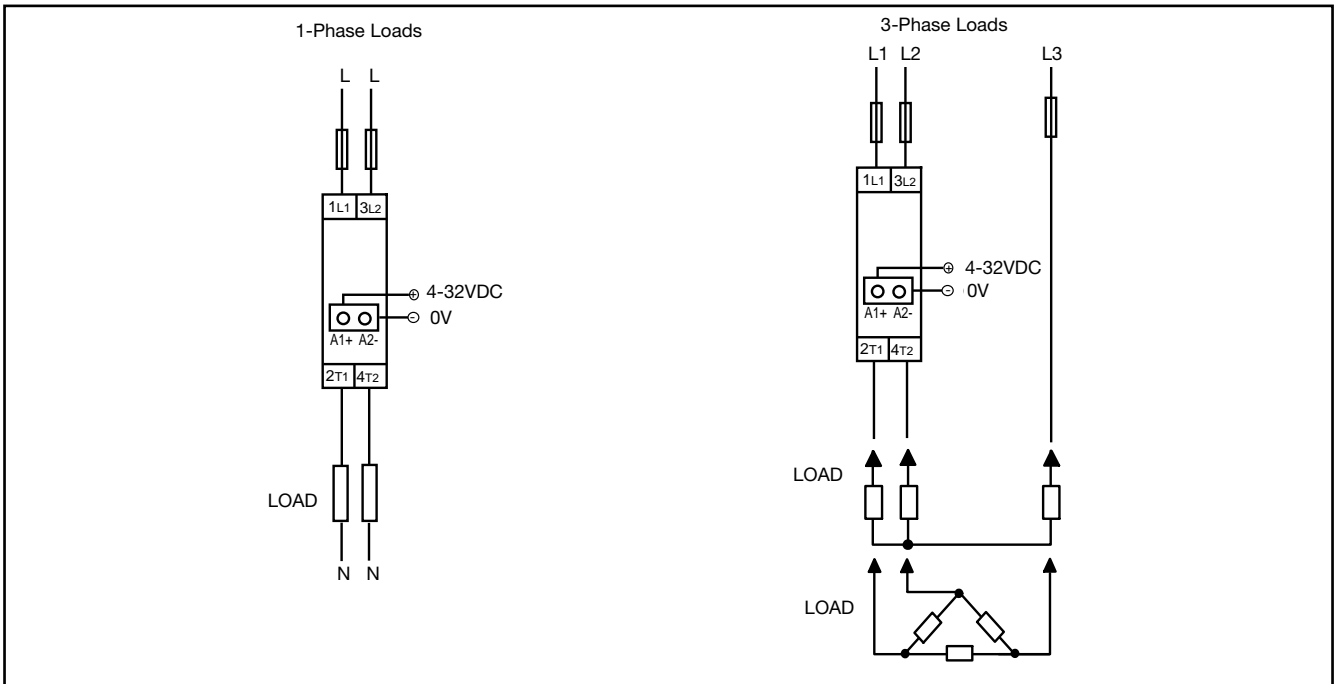

Note: Application of control voltage to terminals A1 - A2 will activate both poles simultaneously.

## Panel Mounting

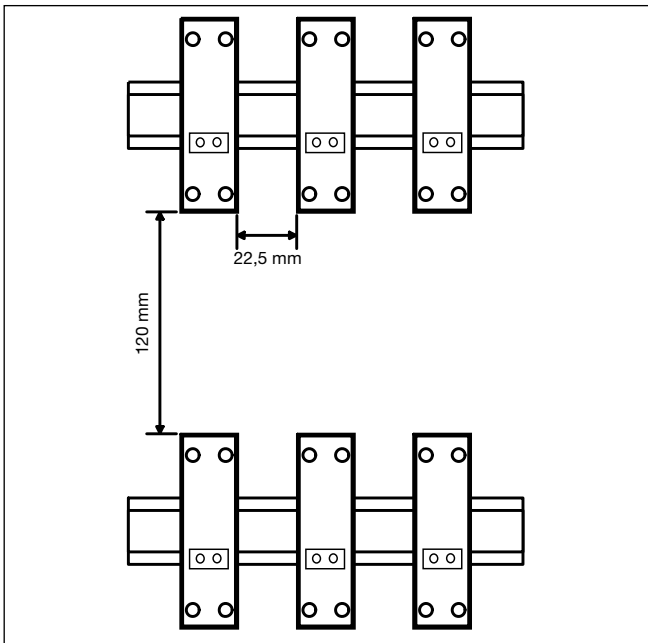

## Dimensions

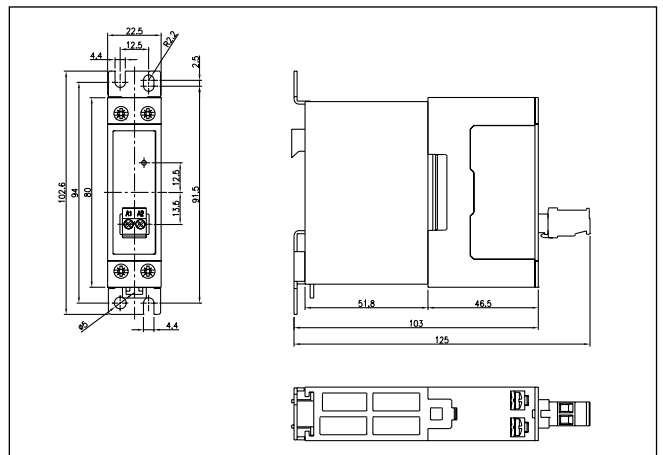

All dimensions are in mm

## Installation

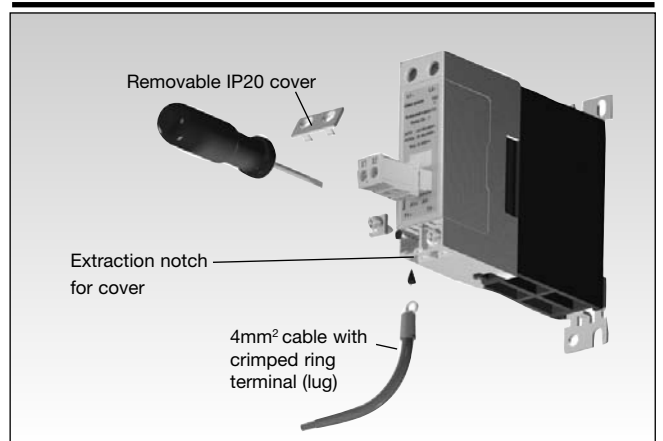

Specifications are subject to change without notice (28.02.2007)